

CONVEYORIZED PIZZA SLICER

The Quantum Pizza Cutter, Model PC5000 is an automated pizza slicer designed to cut pizzas into equal size portions. Interchangeable cutter assemblies allow multiple slice configurations.



MODEL #PC5000

SPECIFICATIONS

PRODUCT:

Rigid Product 3 In. (76mm)
through 18 In. (457mm) Diameter

DRIVE SYSTEM:

Conveyor Utilizes Precision
Electric Drive Motors

UTILITY REQUIREMENTS:

240 VAC., 1 Phase 10 Amp Circuit 60 Hz.
80 Psig @ 6 Scfm.

CONVEYOR:

Heavy Duty Stainless Steel Construction
Wash Down Compatible
Continuous Sanitary Welds
Polyurethane Belting

FEATURES:

- ✓ Slices Pizzas into 3, 4, 5, 6, 7, 8, 9 Equal Portions
(Depending on Cutter Assembly)
- ✓ Up to 40 Pizzas Per Minute
(Depending on Pizza Properties)
- ✓ One Cutter Assembly Included
- ✓ Easy to Remove/Install Blades
- ✓ Hardened Stainless Steel Blades With Guarding
- ✓ Dishwasher Safe Parts
- ✓ Low Maintenance
- ✓ No Tools Necessary For Sanitation
- ✓ Adjustable Locking Casters, No Exposed Threads



QUANTUM®

WWW.Q-T-S.COM

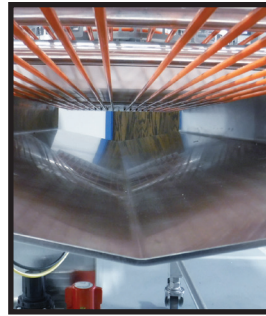
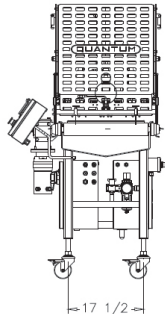
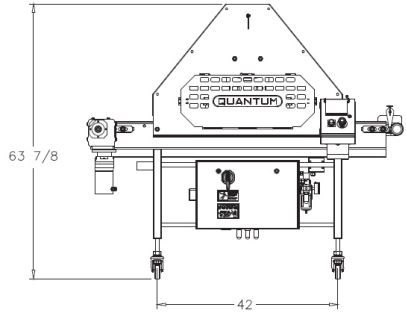
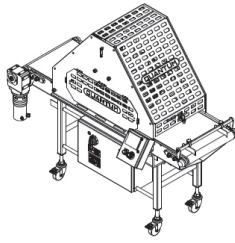
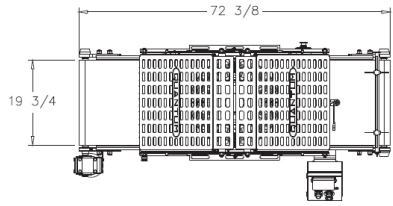

Stainless Steel Catch Tray



Solid Stainless Steel Round Bar Construction



Polycord Conveyor

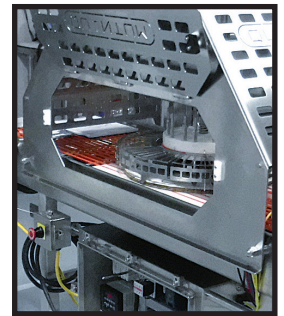

Easy Access To Slicing Head

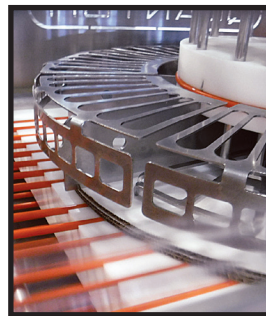

Blade Guards



Adjustable Locking Casters



7" Color Touch Screen

QUANTUM[®]

CONTACT US: +1 815.464.1540
 INFO@Q-T-S.COM | WWW.Q-T-S.COM
 U.S.A.

PORTION & APPLY

TOP IT | FILL IT | SLICE IT